

Formation of Carbonyl Sulfide (COS) on Different Adsorbents in Natural Gas Treatment Plants

By V. CHOWANIETZ, CHR. PASEL, T. ECKARDT, A. SIEGEL and D. BATHEN*

Abstract

Treatment of natural gas by means of adsorption is a widely used technology. If H_2S and CO_2 are present in the natural gas, the formation of COS can occur and can be one of its major drawbacks. Until today COS formation mechanisms are not fully understood. In dynamic breakthrough experiments gas mixtures containing CO_2 and H_2S are contacted over a 5A zeolite and a silica alumina gel. Each adsorbent is studied with regard to COS formation. It is shown that on the silica alumina gel COS is formed to a much lower extent than on the zeolite. This is attributed to structural and chemical differences of the adsorbents as the zeolite is able to remove water from the reaction by selective adsorption and thereby causes a shift in the reaction equilibrium of COS formation. The results are in accordance with the formation mechanisms described in the literature.

1 Introduction

Natural gas contains important quantities of different components in addition to methane. It is a complex mixture of hydrocarbons from ethane up to very high molecular weight hydrocarbons. These can be partially recovered as valuable liquids. The water-saturated natural gas also includes contaminants, e. g. mercaptans or acidic components such as carbon dioxide (CO_2) and hydrogen sulfide (H_2S), which must be removed. The latter is toxic, causes corrosion in technical installations and is transformed into SO_x when burned. Therefore, natural gas has to be processed before it can be separated into specific product streams.

A common process in natural gas drying and purification is adsorption. Depending on the final product specification, feed temperature and gas composition different polar adsorbents like zeolites (molecular sieves),

* Volkmar Chowanietz, Christoph Pasel, Chair of Thermal Process Engineering, University Duisburg-Essen, Duisburg, Germany; Tobias Eckardt, Angela Siegel, BASF Catalysts Germany GmbH, Nienburg, Germany; Dieter Bathen, Chair of Thermal Process Engineering, University Duisburg-Essen, Duisburg, Germany, IUTA Institute of Energy & Environmental Engineering, Duisburg, Germany (E-mail: Volkmar.Chowanietz@uni-due.de),

activated alumina or silica alumina gels are used [1].

Depending on plant design and purification needs, the task of the adsorption unit is natural gas dehydration exclusively or additionally the removal of other components such as higher hydrocarbons (hydrocarbon recovery unit (HRU)), mercaptans or mercury. At the end of the adsorption cycle the adsorber bed is commonly regenerated with hot bone-dry feed gas.

If H_2S and CO_2 are present simultaneously, the formation of carbonyl sulfide (COS) is one of the major drawbacks of adsorption processes, where molecular sieves are employed. COS is created according to the following overall reaction equation.

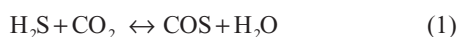

COS is a toxic gas which can cause catalyst poisoning, for example when natural gas is used as a hydrogen source for ammonia synthesis [2]. In the processing of natural gas COS can affect the recovery of Natural Gas Liquids (NGL). During the liquefaction of the C_3/C_4 fraction of sweet gas, COS contaminates the liquid propane stream due to the similar boiling points of COS and propane. COS itself is not corrosive but in the presence of water it reacts back to CO_2 and H_2S and may cause stress corrosion cracking. Avoiding 4A molecular sieves can minimize the formation of COS, but it is still a common problem in dehydration units containing 5A or other molecular sieves.

In cases where dew point requirements are

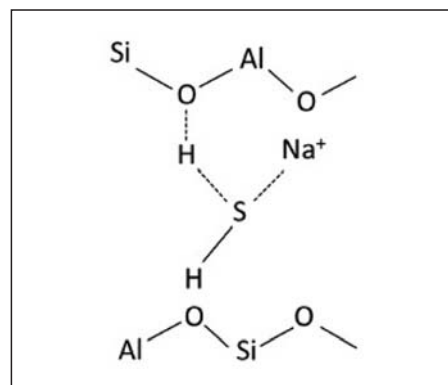

Fig. 1 Interaction model of an adsorbed H_2S molecule on the zeolite surface, according to [5]

not so stringent (e. g. pipeline transport) silica-alumina gels are commonly used for dehydration or hydrocarbon recovery units. In units equipped with Sorbead®-adsorbents, COS formation has never been reported.

Against this background a research collaboration between the BASF Company, which delivers silica gels as well as molecular sieves, and the University of Duisburg-Essen was established. The aim of this research project was to confirm the information from the plant operators and to get an insight into the formation of COS on both classes of adsorbents.

2 Literature Review

There are several research works in the literature that deal with the formation of COS during the adsorption of CO_2 and H_2S using zeolites as adsorbents. Cines et al. examined the desulfurization of natural gas with different zeolites in a series of dynamic adsorption experiments. The tested zeolites, namely 4A, 5A and 13X, showed a different catalytic activity for the formation of COS. The lowest catalytic activity was found on the 5A zeolite. The 4A zeolite exhibited medium catalytic activity and the highest activity appeared on the 13X zeolite [2].

In IR spectroscopic studies on the adsorption of H_2S on a 4A and a 5A zeolite Förster et al. found that during the adsorption on 4A zeolites, part of the H_2S dissociates to SH^- and binds chemically on the surface of the adsorbent. On the 5A zeolite, no dissociative adsorption was detected [3]. Systematic research with zeolites of different cation type and exchange degree, substantiated the mechanism. The catalytic activity correlated with the number of weakly coordinated cations [4]. Bülow et al. concluded, that the SH^- group of the H_2S molecule orientates to weakly coordinated cations, while the proton interacts with lattice oxygen, which links silicon and alumina (Fig. 1). This dissociative adsorption is supposed to cause high reactivity of H_2S and to catalyze the formation of COS [5].

By exchanging single charged cations with double charged cations the number of weakly coordinated cations in type A zeolites is reduced. At an exchange degree of $\geq 67\%$ all weakly coordinated Na^+ cations

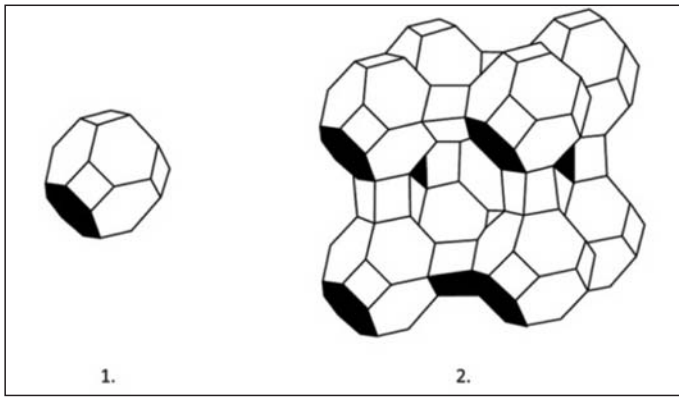

Fig. 2 Zeolite structure: 1. sodalite cage (β-cage); 2. unit cell of type A zeolite. Eight sodalite cages linked through four-member prisms forming a central cage (α-cage) [7]

are removed and the catalytic activity seems to decrease strongly due to the absence of dissociative adsorption. As a result, the conversion of H₂S to COS is strongly reduced, although it cannot be suppressed completely [5, 6].

The catalytic activity of zeolites only influences the reaction velocity but the equilibrium state remains unaffected. Static experiments on 5A zeolites, which exhibit low catalytic activity, and on 3A zeolites, whose active cation sites are inaccessible for CO₂ and H₂S for steric reasons, show high formation of COS with long contact times. Lutz et al. attributed this to the selective adsorption of water in the sodalite cages, which causes spatial separation of the reactants. The sodalite cages, as shown in Figure 2, can be entered through a six-member ring with a free diameter of 2.8 Å [7]. Water is the only molecule of those involved in reaction 1 that is small enough to enter the sodalite cages. The other molecules adsorb in the central cages. Therefore, the water formed during the reaction is not available for the back reaction and the equilibrium shifts to the right side of the equation. Because the reaction still needs to be activated, it is concluded that the zeolite framework, independent of its type, catalyzes the formation of COS as well. For indirect support of this thesis, the conversion of H₂S to COS was examined on a microporous silica gel that is catalytically inactive and cannot spatially separate water and COS because of its pore structure. No formation of COS could be found, which confirms the proposition about the effect of water on the equilibrium [6].

In the literature, the influence of silica gels and of silica alumina gels on the conversion of H₂S to COS is thought to be low [1] but has not yet been studied systematically. Against this background the current work compares COS formation on a 5A zeolite with minimal catalytic activity and on a silica alumina gel by dynamic breakthrough experiments. The purpose of the experiments was to further investigate the mechanisms described above and to examine the influence of the silica alumina gel on COS formation.

Table 1 Gas compositions

| System No. | Gas compositions, % | | | |
|------------|---------------------|-----------------|------------------|------------------|
| | N ₂ | CO ₂ | H ₂ S | H ₂ O |
| 1 | – | 99 | 1 | – |
| 2 | 50 | 49.5 | 0.5 | – |
| 3 | 90 | 9.9 | 0.1 | – |
| 4 | 96 | 3.96 | 0.04 | – |
| 5 | 88.2 | 9.9 | 0.1 | 1.8 |

3 Experimental Section

3.1 Materials

A 5A zeolite and the silica alumina gel Sorbead® H were

tested. Both materials were provided by BASF Catalysts GmbH in the form of spherical particles. The measurement of nitrogen isotherms at 77K for zeolite and Sorbead® H determined BET surfaces of 568 m²/g and 737 m²/g, respectively. The 5A zeolite is a CaNaA zeolite produced from a 4A zeolite by exchanging Na⁺ cations with Ca²⁺ cations. The degree of exchange is ≥ 65% according to the product sheet. The Sorbead® H is a silica alumina gel with an Al₂O₃ content of 3%. The surface of silica gels is occupied by polar silanol groups and Lewis acid active sites built by alumina. H₂S (99.5%) and CO₂ (99.998%) were purchased from Air Liquide. The H₂S contains a trace of COS, which has to be taken into account when evaluating the experiments. The gas chromatograph was calibrated with certified test gases, also purchased from Air Liquide.

3.2 Experimental unit and procedure

The experiments are performed by supplying a gas stream containing H₂S and CO₂ on an adsorber bed while measuring the COS

concentration at the adsorber outlet. The experimental setup is shown in Figure 3.

Before starting the experiment, the adsorbents are activated for at least 12 hours at 300 °C under ambient air. The adsorber has a height of 18 cm and an inner diameter of 3.8 cm. After filling the adsorbent to a height of 10.5 cm into the adsorber the fixed bed is purged with dry nitrogen (<2 ppm H₂O) to cool it down to the process temperature of 100 °C. Subsequently feed gas is mixed from component gases with thermal mass flow controllers to achieve a volume flow of 1 l_v/min and routed to the gas analytics via a bypass. For experiments with wet feed gas part of the volume flow is passed through a bubbler.

The gas is analyzed with a Varian micro gas chromatograph CP-4900. With a packed column for polar components the concentrations of CO₂, H₂S and COS can be measured simultaneously. A heat conductivity detector (HCD) with a lower resolution boundary of 1 ppm is used as a sensor. The concentration of water is measured spectroscopically with a Tunable Diode Laser Absorption Spectrometer (TDLAS).

After reaching constant feed gas concentrations, the gas is led upstream through the adsorber and the outlet concentration of the adsorptives is measured. During the adsorp-

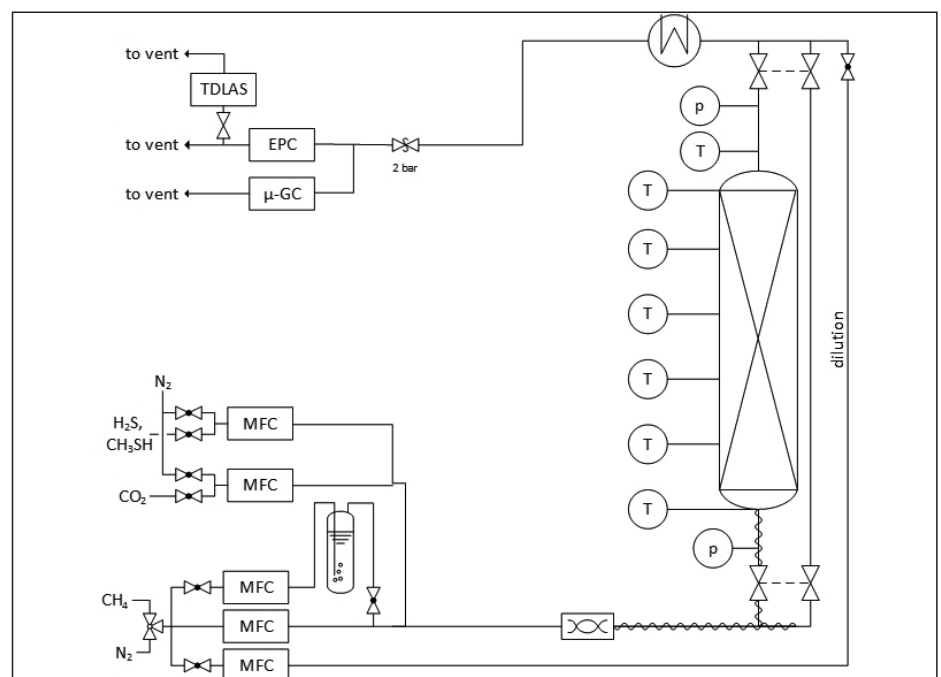

Fig. 3 Flow diagram of experimental unit

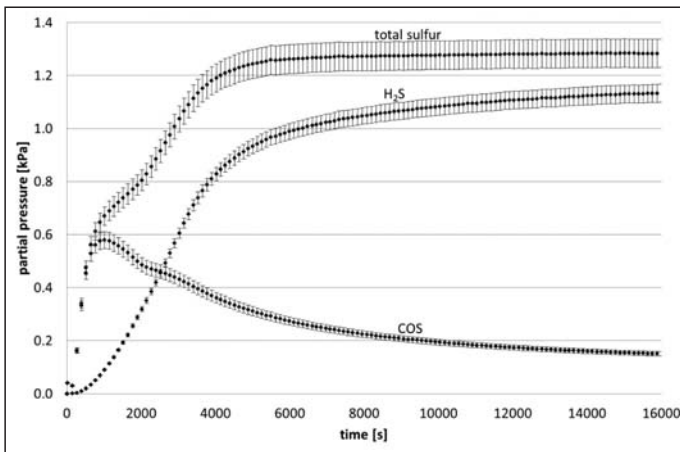

Fig. 4 Breakthrough curves of the sulfur compounds after adsorption of the undiluted CO₂/H₂S gas mixture (99/1) on the 5A zeolite at 100 °C. Total sulfur corresponds to the accumulated concentration of both sulfur species

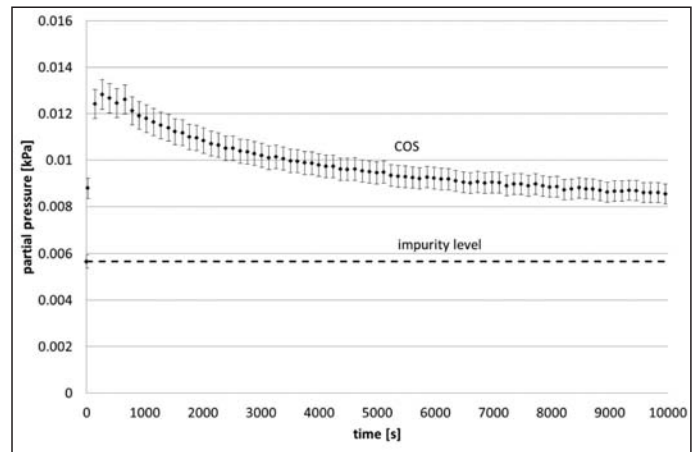

Fig. 5 Breakthrough curve of COS after adsorption of the undiluted CO₂/H₂S gas mixture (99/1) on the Sorbead[®] H at 100 °C. The dashed line represents the COS-impurity contained in H₂S supply

tion process, thermo couples measure the temperature at the inlet and outlet of the adsorber as well as at different positions in the fixed bed. With an assumed average outer porosity of 0.4 the residence time of the gas inside the fixed bed is four seconds. A pressure controller regulates the system pressure at 1.3 bar_a for the entire duration of the experiment. All experiments are conducted with a constant CO₂/H₂S ratio of 99/1. The partial pressure was reduced by stepwise dilution with nitrogen. All adsorption experiments were carried out at 100 °C. This process temperature was chosen after preliminary research showed no formation of COS at ambient temperature in a comparable setup [8]. The tested systems are shown in Table 1. The experiment with 90% dilution was performed under dry and wet (1.8% H₂O) conditions to deduce the influence of water in the feed gas.

4 Results and Discussion

Figure 4 shows breakthrough curves of the sulfur compounds after adsorption of the undiluted binary CO₂/H₂S feed gas (99/1) on the 5A zeolite. For the entire duration of the experiment, no breakthrough of water was detected. Because of the large quantity of the carrier gas CO₂ the change in CO₂ concentration is not significant and therefore not plotted. The relative experimental errors result from the standard deviation determined in repetition measurements and the calibration error due to the uncertainty of test gases. The carrier gas CO₂ saturates the fixed bed and breaks through immediately because of its high concentration. Also, an almost immediate breakthrough of newly formed COS can be seen, due to the zeolite's low capacity for COS. H₂S is adsorbed completely at the beginning of the adsorption process and COS formation takes place in the part of the fixed bed that has been reached by H₂S. With the ongoing adsorption of H₂S in the fixed bed the concentration of COS rises. Shortly after H₂S breakthrough, the conversion rate

which is the ratio of COS outlet concentration and H₂S inlet concentration, reaches its maximum of 44.53%. Subsequently, the conversion rate decreases over a long period of time. After 6000 seconds the accumulated concentration of both sulfur species becomes constant and adsorption equilibrium is reached. From that point on, the shape of the concentration profiles is only influenced by the conversion rate of H₂S to COS. The catalytic activity of the 5A zeolite according to the mechanism in Figure 1 is lowered by sodium exchange and the formation process is activated essentially by the zeolite framework. However, weakly coordinated cations that contribute to the catalytic activity remain due to inhomogeneous sodium exchange. Probably the major influence on the formation of COS is a shift in the reaction equilibrium (Eq. (1)) due to adsorptive water separation as described by Lutz et al. [9]. The preferential adsorption of water inside the sodalite cages leads to a spatial separation from the other three compounds involved in reaction (1). This shifts the reaction equilibrium to the right side. The slow decrease in conversion rate may be explained by the water that is successively formed and adsorbed continuously. We assume that the increasing water adsorption causes local saturation of sodalite cages and so hampers the spatial separation. In addition, due to concurrent adsorption with the preferentially adsorbed water, less sorption sites are available for CO₂ and H₂S. The adsorption of the same gas mixture on Sorbead[®] H is shown in Figure 5. COS is formed to a

very low extent and an immediate breakthrough occurs. The conversion rate at the concentration maximum is 0.54%, which is about two orders of magnitude lower than on the zeolite. The measured COS concentration is only slightly above the impurity from the H₂S supply. The concentration profiles of H₂S and total sulfur are not shown, as the change in H₂S concentration caused by formation of COS is within the statistical error range of the gas analytics. The very low conversion rate indicates that Sorbead[®] H has no significant catalytic activity for formation of COS. In addition it cannot separate water and COS because of its mesoporous pore structure. Further experiments were conducted by reducing the partial pressure of both components by dilution with nitrogen. This was done to determine the influence of gas phase concentration on the conversion rate of H₂S to COS. The maximal conversion rates of the experiments are shown in Figure 6. With increasing degree of dilution the conversion rate on both adsorbents decreases. On Sorbead[®] H the conversion rate decreases to 0.1% when the gas mixture is diluted by 50%. Higher degrees of dilution were able to

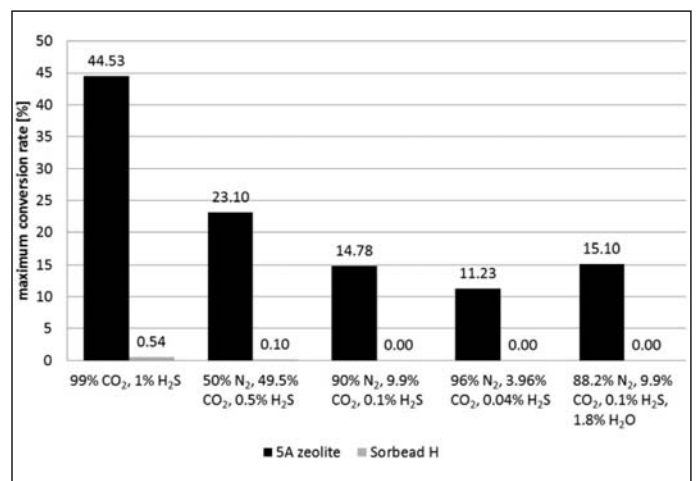

Fig. 6 Maximum rates of H₂S conversion to COS during adsorption on a 5A zeolite and Sorbead[®] H

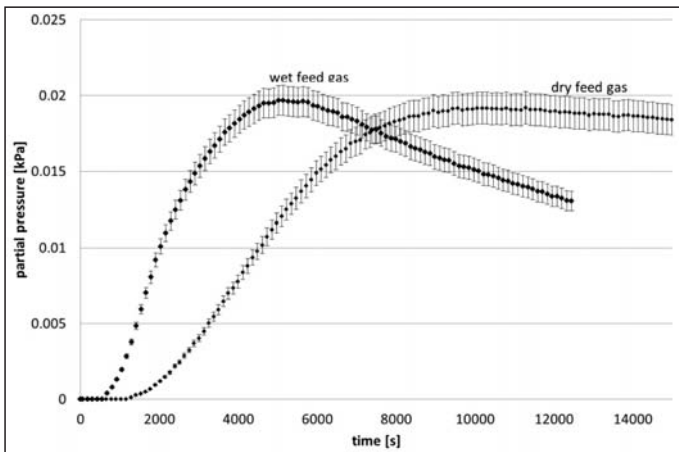

Fig. 7 Comparison of COS breakthrough curves of COS after adsorption of the 90% diluted dry and wet (1.8% H₂O) gas mixture on the 5A zeolite at 100 °C

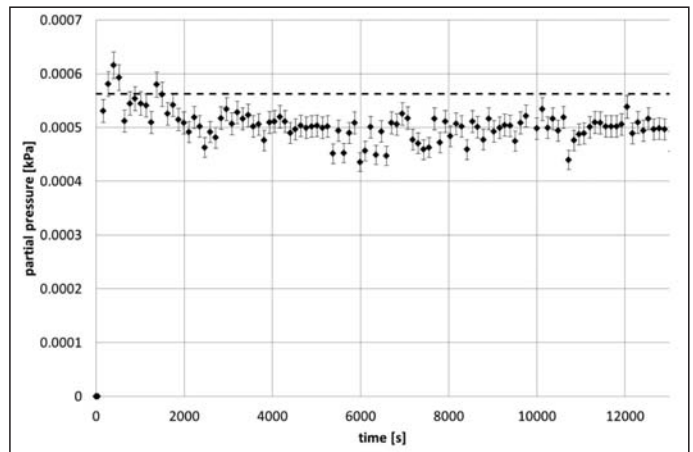

Fig. 8 COS breakthrough curve of the 90% diluted wet gas mixture (1.8% H₂O) on Sorbead[®] H. The dashed line represents the COS-impurity contained in hydrogen sulfide supply

completely suppress formation of COS in this setup. In contrast, formation of COS could be observed on the zeolite even at 96% dilution.

Figure 7 compares the COS breakthrough curves of the experiments with 90% diluted dry and wet feed gas. The presence of water significantly affects the H₂S conversion rate on the 5A zeolite. One can observe that the maximum concentration of COS in both experiments differs only slightly but there is an apparent effect on the decrease of the conversion rate. In addition to the water formed by the conversion of H₂S to COS, water contained in the feed gas continuously saturates the adsorber bed. It can be assumed that the increased amount of adsorbed water accelerates the decrease of the conversion rate by speeding up blocking of sodalite cages and sorption sites.

On Sorbead[®] H, as shown in Figure 8, the concentration of COS drops slightly below the impurity of the H₂S supply after a short time. This may be due to the reverse reaction of COS to H₂S and CO₂. However, as the difference between the detected COS concentration and the COS impurity is only slightly larger than the experimental error, this finding should be treated with caution.

5 Summary

The formation of COS during the simultaneous adsorption of CO₂ and H₂S on a 5A zeolite and on the silica alumina gel Sorbead[®] H was investigated in dynamic experiments. On Sorbead[®] H COS formation occurred to a much lower extent than on the zeolite. The reason is the ability of zeolites to spatially separate water and COS. This causes a shift of the reaction equilibrium. The mesoporous Sorbead[®] H cannot separate the reactants and consequently the equilibrium is not shifted. In addition, no significant catalytic activity could be observed.

With lower gas phase concentrations of CO₂ and H₂S in the feed gas the maximum conversion rate decreased. On Sorbead[®] H COS formation was suppressed completely at

high degrees of dilution. The presence of water in the feed showed no influence on the maximum conversion rate but accelerated its decrease over time.

The experimental results are in accordance with the COS formation mechanisms found in the literature.

References

- [1] A. L. Kohl, R. Nielsen: Gas purification, 5th ed., Gulf Pub., Houston, Tex. 1997, S. 1049.
- [2] M. R. Cines, D. M. Haskell, C. G. Houser: Chemical engineering progress 72, 8, 89–93 (1976).
- [3] H. Förster, M. Schuldt: Journal of Colloid and Interface Science 52, 2, 380–385 (1975).
- [4] P. Fellmuth, W. Lutz, M. Bülow: Zeolites 7, 4, 367–371 (1987).
- [5] M. Bülow, W. Lutz, M. Suckow: Studies in Surface Science and Catalysis 120, 301–345 (1999).
- [6] W. Lutz, J.-C. Buhl, H. Thamm: ERDÖL ERDGAS KOHLE 115, 2, 87–89 (1999).
- [7] R. T. Yang: Adsorbents – Fundamentals and applications, Wiley-Interscience, Hoboken, N. J. 2003, S. 159.
- [8] B. Steuten: Adsorptive Entfernung von Schwefelverbindungen aus Erdgas, Dissertation, Universität Duisburg-Essen, Duisburg 2014.



natural gas processing in 2013.

Volkmar Chowanietz is research assistant at the chair of Thermal Process Engineering at the University of Duisburg-Essen. At that university he studied mechanical engineering before he started his PhD thesis in the field of adsorptive



Thermal Process Engineering at University Duisburg-Essen.

Dr. rer. nat. Christoph Pasel has studied chemistry at Ruhr University of Bochum from 1985–1990 and completed his PhD thesis in 1993. Today he works as a senior engineer in the field of adsorption technologies at the Department of



Dr. Tobias Eckardt is Global Product Technology Manager for BASFs adsorbents group. His responsibilities cover two product groups: Claus Catalysts for Sulphur Recovery and Silica Gel adsorbents (Sorbead[®]) for Natural Gas Dehydration

and Hydrocarbon Recovery applications.

He started his industry career back in 2005 in Product Development holding positions with increasing responsibility. Tobias Eckardt earned his PhD in Synthetic Organic Chemistry from University Colleague Cologne and studied Chemistry at University Colleague Göttingen and Dublin with strong focus on Catalysis. He has published numerous scientific papers in various refereed journals, conference proceedings and has several patents granted or pending.



Dr. Angela Siegel was Laboratory Manager R&D for BASFs adsorbents group until January 2016. Since March 2016 she is Manager Catalyst Development at Sasol Germany GmbH. She studied Chemistry at University of Hannover and earned her PhD in Technical Chemistry from University of Hannover in 1995.



Dieter Bathen holds the chair of Thermal Process Engineering at the University of Duisburg-Essen and is scientific director of the Institute of Energy and Environmental Technology IUTA. He is chairman of the ProcessNet working group Ad-

sorption (VDI / DECHEMA) and chairs various VDI guidelines on adsorption. After his studies and doctorate in chemical engineering / process engineering at the University of Dortmund he held various functions in the Degussa Group (now Evonik AG) before moving to his present position in 2007.